

Grid:
 ≥ 1,91 mm
 ≥ 75 Mil

Installation height with KS: 5,8 mm (.228)
 Recommended stroke: 6,0 mm (.236)

Mounting and functional dimensions

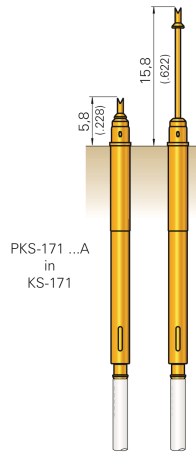
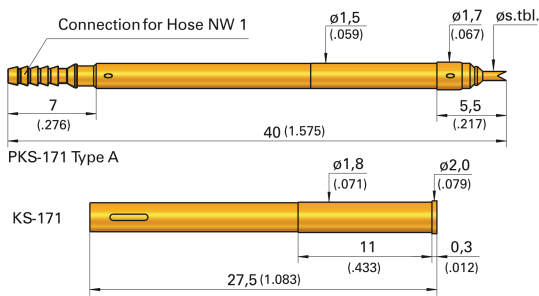

Available tip styles

Material	Tip style	Plating	Further versions	
			∅	∅ (inch)
2 04*		A	∅ 1,00 (.039)	
2 14*		A	∅ 0,50 (.020)	
3 19		A	∅ 1,50 (.059)	
2 91*		A	∅ 1,00 (.039)	

* Diameter of collar: 1,3 mm (.051)

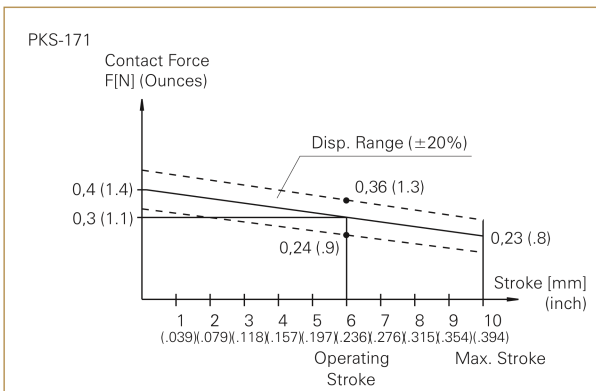

Mechanical data

Switch. path/work. stroke: 6,0 mm (.236)
 Maximum stroke: 10,0 mm (.394)
 Cont. force at work.stroke: 0,3 N (1.1oz)
 Operating medium: Compressed air (filtered, oil-free)
 Operating pressure: 6 bar (86 psi)

Electrical data

Current rating: 1 - 2 A
 R_i typical: < 30 mΩ

Operating temperature

Standard: 0° up to +80 °C

Materials

Plunger: Steel, gold-plated
 Barrel: Brass, gold-plated
 Restoring spring: Steel, gold-plated
 Receptacle: Brass, gold-plated
 O-rings: Perbunan

Mounting hole size

with receptacle KS-171:
 ∅ 1,79 - 1,80 mm (.0705 - .0709)
 without receptacle: ∅ 1,49 mm (.0587)

Warning:

Do not solder the cable to the crimp points of the receptacle.

Note:

The assembly in grid size 1,91 mm (75 Mil) is only possible up to a double row, and then only without use of receptacles.

Note:

The receptacles can be used from grid size 2,54 mm (100 Mil) upwards.

Ordering example

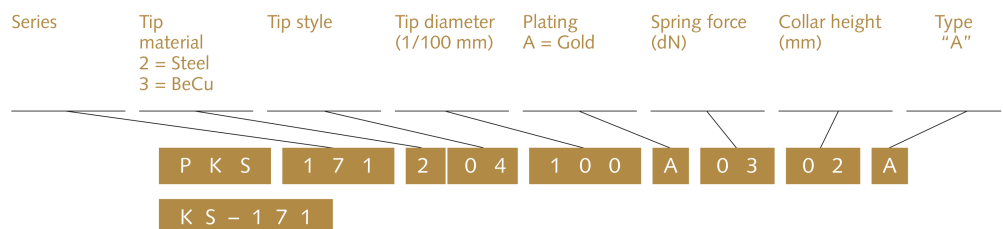

Test probe:

Receptacle:

Pneumatic test probes can be actuated and controlled individually or in groups.

Example of set-up and layout:

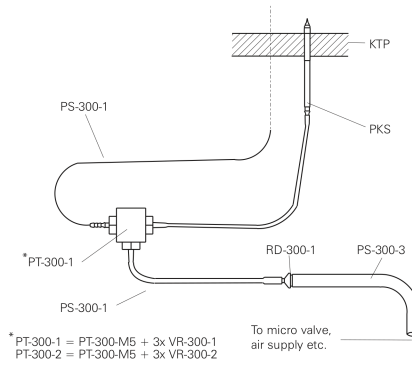
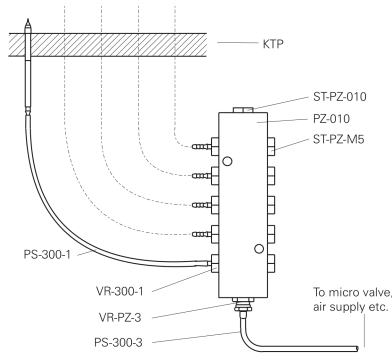

General notes:

A compressed air hose with a standard width of 1 mm (NW1) or 2 mm (NW2) is required to connect pneumatic probes. A range of adapters (see table below) are offered to establish air feed lines from commercially available compressed air hose NW3 or from compressed air distributors with threaded terminals M5.

The hose NW1 should only be used for short distances. The larger diameter of 3 mm guarantees good operating pressure.

The electrical connection is established by first soldering the wire to the KL-300 clip, then fixing the clip onto the end of the pneumatic test probe. (Refer to marked positions in the drawings on the previous data sheets).

To avoid damage to the ends of the hose, only the recommended specialised cutter tool SS-101 should be used

The various connections plates are controlled using micro-valves. Instead of a micro-valve, a sealing plate (DP-1) can be used to seal the air outlet holes.

Item	Tech. designation	Order number
Reducer piece	NW 3 / NW 1	RD-300-1
Reducer piece	NW 1 / NW 2	RD-300-1-2
Reducer piece	NW 3 / NW 2	RD-300-2
Threaded terminal	M 5 / NW 1	VR-300-1
Threaded terminal	M 5 / NW 2	VR-300-2
Threaded terminal	M 5 / NW 3	VR-300-3
Threaded terminal	M 3 / NW 1	VR-200-1
Threaded terminal	M 3 / NW 2	VR-200-2
Threaded terminal	M 3 / NW 3	VR-200-3
T-Piece (without threaded terminal)	3 x M 5	PT-300-M5
T-Piece incl. 3 x VR-300-1	3 x NW 1	PT-300-1
T-Piece incl. 3 x VR-300-2	3 x NW 2	PT-300-2
Ten-fold distributor	10 x M 5	PZ-010
Compressed-air hose, Ø _i 1,2; Ø _o 2,0	NW 1	PS-300-1
Compressed-air hose, Ø _i 2,0; Ø _o 3,9	NW 2	PS-300-2
Compressed-air hose, Ø _i 2,6; Ø _o 4,0	NW 3	PS-300-3
Specialised cutting tool		SS-010
Dummy plug for distributor	B1/8	ST-PZ-010
Dummy plug for distributor	M 5	ST-PZ-M 5
Plug for distributor	M 5-1/8a	ST-PZ-VR
Terminal for hose NW 3	NM 5-PK 3	VR-PZ-3
Terminal for hose NW 4	NM 5-PK 4	VR-PZ-4
3/2 Micro-valve 12V (0,95 W)		MV 12
3/2 Micro-valve 24V (0,95 W)		MV 24
Single-connection plate	for 1 valve	ASP-1
Multi-connection plate	for 2-10 Valves	ASP-X
Sealing plate	for conn. plate	DP-1
Silencer	M3	28574
Silencer	M5	3981

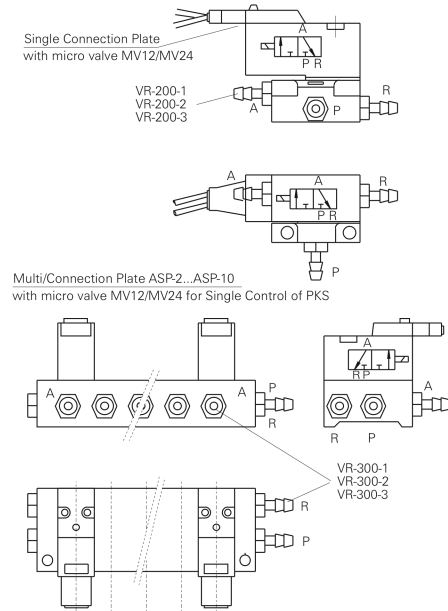

Ordering examples to activate and control 5 PKS-300

Simultaneously activation and control	Separate activation and control	Item	Order number
5	5	Pneumatic test probes	PKS-300 xxx xxx x xx02 x
x meter	x meter	Compressed-air hose NW 1	PS-300-1
1	-	Ten-fold distributor	PZ-010
1	-	Dummy plug	ST-PZ-010
1	1	Terminal for hose NW 3	VR-PZ-3
5	5	Terminal for hose NW 1	VR-300-1
x meter	x meter	Compressed-air hose NW 3	PS-300-3
1	5	Microvalve 24V or 12V(incl. plug)	MV 24 / MV 12
1	-	Single-connection plate for microvalve	ASP-1
-	1	Single-connection plate for microvalve	ASP-5
2	-	Terminal for hose NW 3	VR-200-3
5	2	Dummy plug for distributor	ST-PZ-M5
-	1	Terminal for hose NW 3	VR-300-3
-	1	Silencer	3981

Single Connection Plate (ASP-1)

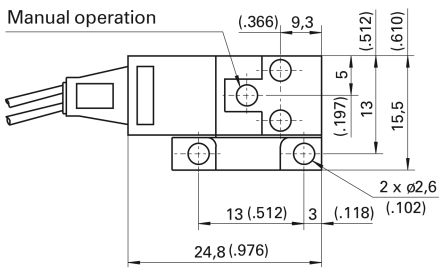
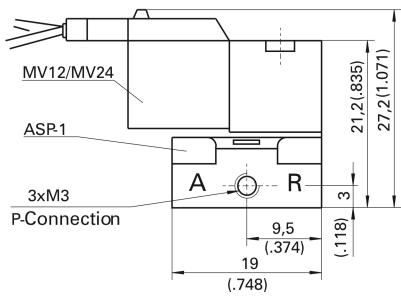

Multi Connection Plate (ASP-2...-10)

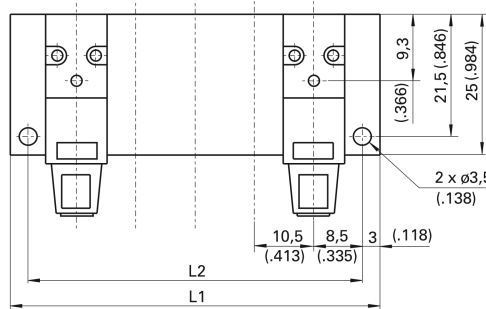
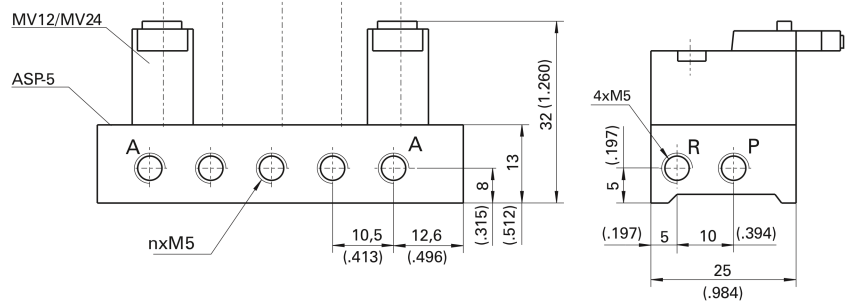
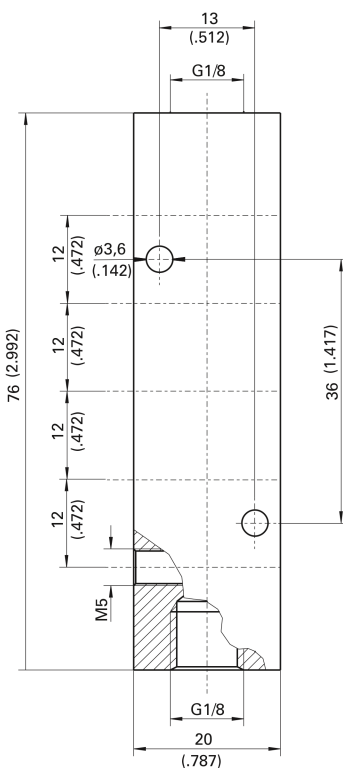
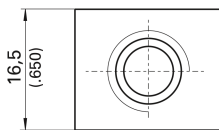

Table of Dimensions for Multi Connection Plate

Number Valves	L1	L2
2	33,5 (1.319)	27,5 (1.083)
3	44,0 (1.732)	38,0 (1.496)
4	54,5 (2.146)	48,5 (1.909)
5	65,0 (2.559)	59,0 (2.323)
7	86,0 (3.386)	80,0 (3.150)
8	96,0 (3.780)	90,5 (3.563)
9	107,0 (4.213)	101,0 (3.976)
10	117,5 (4.626)	111,5 (4.390)

Ten-fold distributors (PZ-010)



T-piece (PT-300-M5)

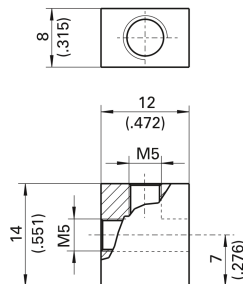

Threaded Terminal M3	Threaded Terminal M5	Reducers	Plugs for Distributors PZ-010
 VR-200-1	 VR-300-1	 RD-300-1	 ST-PZ-VR
 VR-200-2	 VR-300-2	 RD-300-1-2	 VR-PZ-3
 VR-200-3	 VR-300-3	 RD-300-2	 VR-PZ-4