

HF66-0009 SWH 6 S M-SMP

**Contacting
SWH-Female**

NEW

Centers (mm/mil)	5,00 / 197
Current (Circular)	0,5 A
Current (Internal)	0,1 A
Impedance [Z]	50 Ohm
Frequency	6 GHz
Temperature	-20°C...+80°C

Spring Force (cN ±20%)

	Preload	Nominal
Total	-	480
Internal Cont.	95	120
Circular Cont.	240	360

Travel (mm)

	Nominal	Maximum
Internal Cont.	0,5	0,8
Circular Cont.	2,0	3,0
Thread		M4,5x0,35
Wrench Size		3,3 / 4,0

Materials and Plating

Internal Cont.	BeCu, gold plated
Circular Cont.	Brass, gold plated
Barrel	Brass, gold plated
Spring Internal Cont.	Music Wire, gold plated
Spring Circular Cont.	Stainless steel, unplated

Drill Size (mm)

Thread	M3,5x0,35
--------	-----------

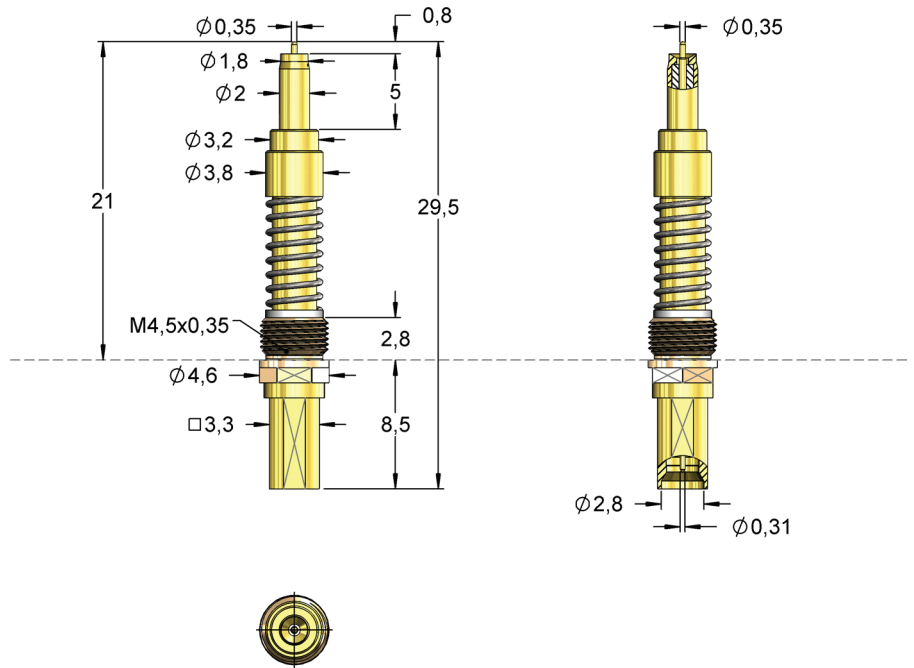

Connection with Mini SMP female.

RADIO FREQUENCY PERFORMANCE

Typical insertion loss	DC up to 3 GHz	3 GHz up to 6 GHz
Maximum	0,4 dB	0,7 dB
Typical return loss	DC up to 3 GHz	3 GHz up to 6 GHz
Minimum	20 dB	14 dB

This table shows the reference values in the middle and at the end of the recommended frequency.

Order Code	Description	Sensepin	Tip Style	Ø A	Ø B	C	H	L	Version
HF66-0009	HF66-0009 SWH 6 S M-SMP		11	0,35	1,80	0,80	21,00	29,50	-





CONNECTION CABLES

for Types HF860/HF66

Connection Cables for HF860

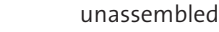
Connection element with pre-assembled coaxial cable RG 316.
Impedance: 50 Ohm
Cutoff frequency: recommended up to **3 GHz**

H86oAE1  Coax cable 3GHz 700 mm  **MCX-M straight** **unassembled**

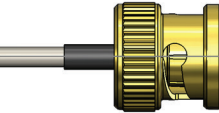

H86oAE3  Coax cable 3GHz 700 mm  **MCX-M straight** **SMA-M straight**

H86oAE4  Coax cable 3GHz 700 mm  **MCX-M straight** **BNC--M straight**

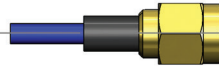
Connector with pre-assembled coaxial cable Multiflex 86.
Impedance: 50 Ohm
Cutoff frequency: recommended up to **10 GHz**

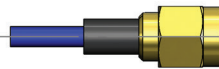

H86oAE2  Coax cable 10GHz 700 mm  **MCX-M straight** **SMA-M straight**



H86oAE5  Coax cable 10GHz 1500 mm  **MCX-M straight** **SMA-M straight**

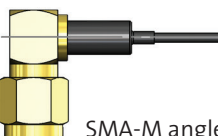

H86oAE6  Coax cable 10GHz 800 mm  **MCX-M angled** **SMA-M grade**

Connection Cables for HF66

Connector with pre-assembled highly flexible coaxial cable.
Impedance: 50 Ohm
Cutoff frequency: recommended up to **6 GHz**

H66AE1  Coax cable 6GHz 700 mm  **SMA-M angled** **mSMP-F straight**

H66AE2  Coax cable 6GHz 700 mm  **SMA-M straight** **mSMP-F straight**

H66AE3  Coax cable 6GHz 300 mm  **SMA-M angled** **SMA-M straight**



Mounting of the new RF series

Mounting Options

For the new RF probe series HF66 and HF05 different mounting options are possible.

Some probes can be threaded directly into the mounting plate.

Some versions have a flange that is screwed to the mounting plate, this version allows a simple adjusting and contacting of the DUT. The drill hole for mounting needs to have a sufficient diameter to allow a movement of the probe.

Mounting example 1

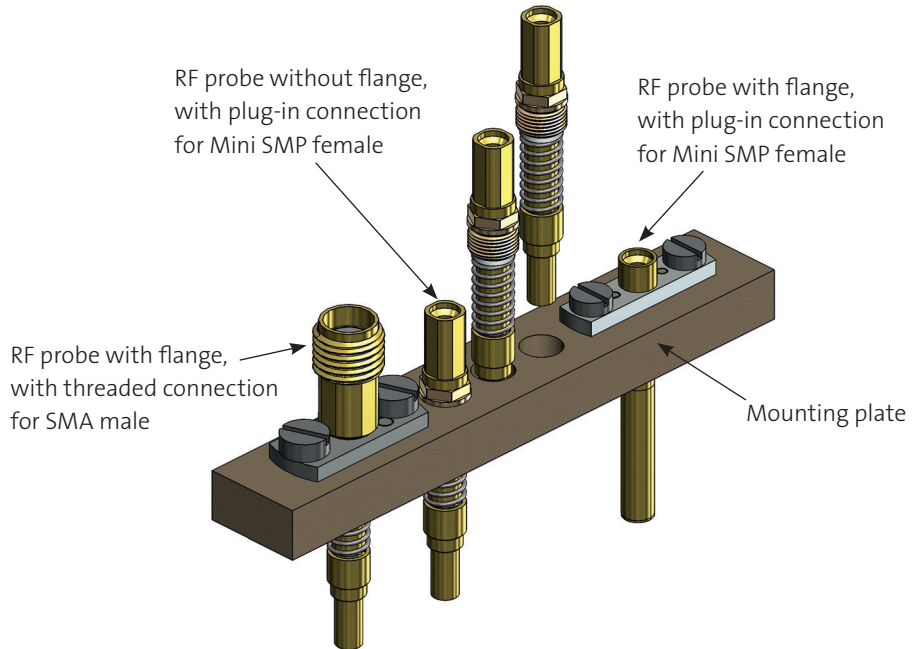

Mounting with Flange

For mounting RF probes with flange drill holes for the centering pins, threaded holes for the fixing screws as well as guiding holes for the probe are needed. These need to correspond with the pattern of the flange.

At first, the RF probe is inserted into the guiding hole and brought into the correct position with the alignment pins.

Afterwards the RF probe can be fixed with the screws.

The last step is the connection of the probe with a suitable connection cable. We recommend coaxial cables with low attenuation and low stiffness, because the cables move with the end of the probe when the probe is compressed and they need to allow a certain movement of the probes.

Mounting example 2

