



HF60-0009 GSG 6 P MCX 135

Contacting PCB-GSG

NEW

Centers (mm/mil)	6,00 / 236
Current (Circular)	10,0 A
Current (Internal)	3,0 A
Impedance [Z]	50 Ohm
Frequency	6 GHz
Temperature	-20°C...+80°C

Spring Force (cN ±20%)

	Preload	Nominal
Total	-	960
Internal Cont.	0	0
Pins		
Circular Cont.	2x40	2x80
Core		
Circular Cont.	450	800

Travel (mm)

	Nominal	Maximum
Internal Cont.		
Pins		
Circular Cont.	1,0	1,5
Core		
Circular Cont.	4,0	5,0
Thread (M)		M5x0,5
Wrench Size		3,5 / 4,0 / 5,0

Materials and Plating

Internal Cont.	BeCu, gold plated
Circular Cont.	BeCu, gold plated
Barrel	Brass, gold plated
Spring	
Internal Cont.	Music Wire, gold plated
Spring	
Circular Cont.	Stainless steel, unplated
Receptacle	Brass, gold plated

Drill Size (mm)

H860	4,99 - 5,00
H860RD	5,51 - 5,53
H860FL	7,99 - 8,01

Projection Height (mm)

H860(RD) with HF60-0002	12,9
H860FL with HF60-0002	14,0

Accessories

Internal pin	-
Tool for changing internal pin	-
Insertion tool receptacle	FEWZ-822E0
Cables see overview	page 62

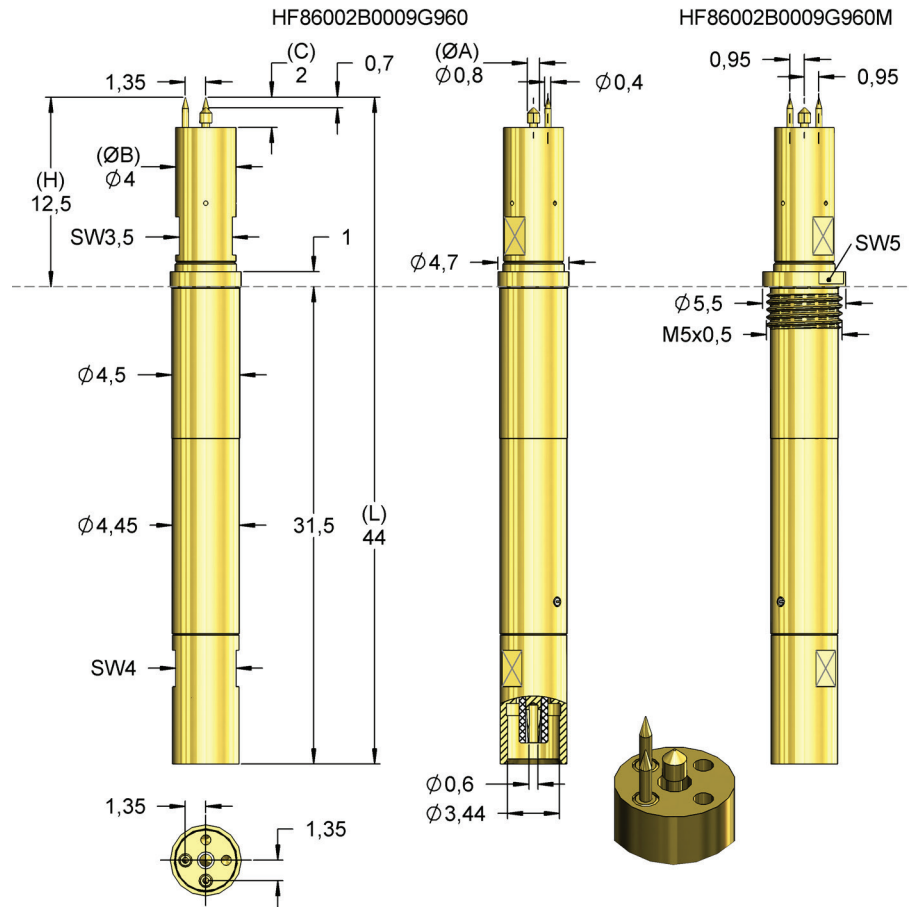

For contacting PCBs. The signal pin is not spring loaded. The ground pins have a spring force of 80 cN. Suitable mounting receptacles see H860 or H860FL.

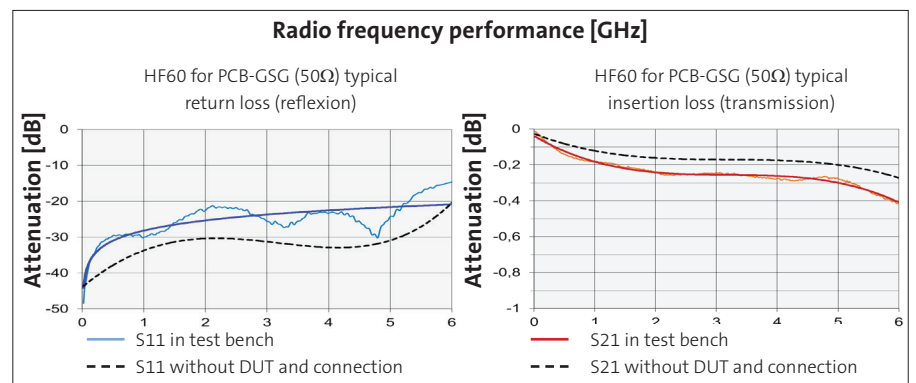
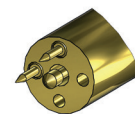
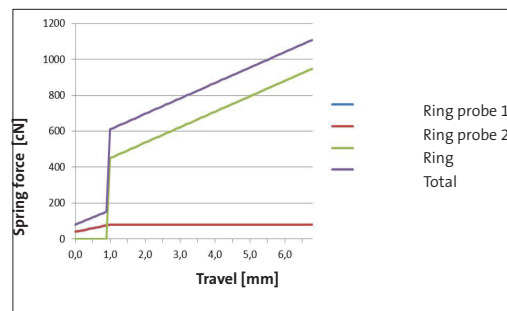

Order Code	Description	Sensepin	Tip Style	Ø A	Ø B	C	H	L	Version
HF86002B0009G960	HF60-0009 GSG 6 P MCX 135		02	0,80	4,00	-0,70	12,50	44,00	-
HF86002B0009G960M	HF60-0009 GSG 6 S MCX 135		02	0,80	4,00	-0,70	12,50	44,00	M



Receptacles

for HF860

The new receptacle H860FL allows a flexible (floating) mounting of the high frequency probe HF60. It permits a wobbling by 360 degrees in case of a small offset to the DUT. Such a possible offset is compensated without damaging the DUT. In released mode the HF probe is returned to its zero point position. The screwable receptacle with knurl (H860RD) is available for the screwable versions of the HF860.

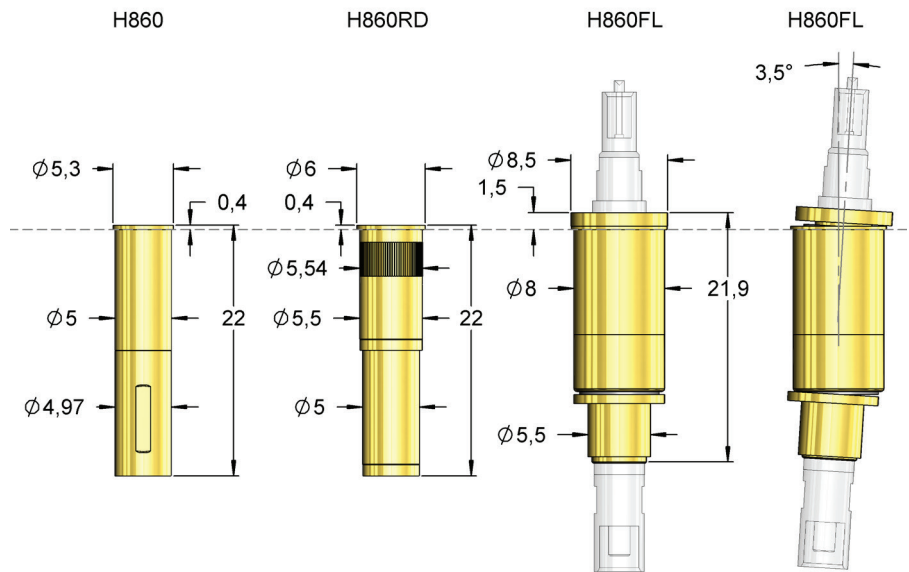

Tools

for HF860

FWZ860HF50

The FWZ860HF50 is used to screw the probes HF860...M into the screwable receptacle H860RD.

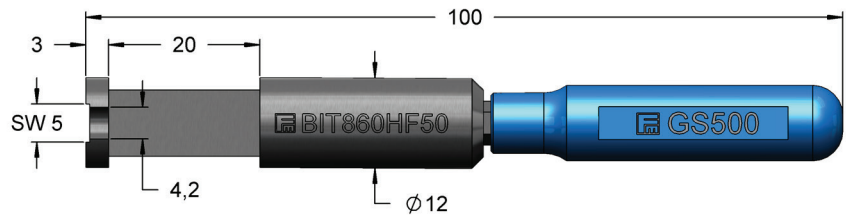

FEWZ-822E0

The FEWZ-822E0 is used to insert the receptacles H860... into the mounting plate.

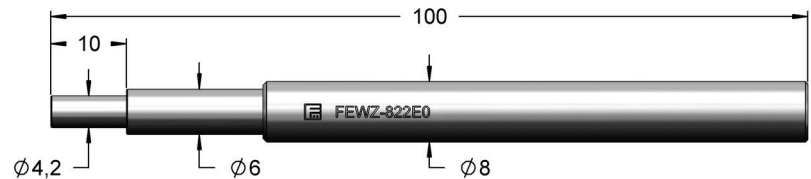

FDWZ-050

The FDWZ-050 is used to insert the signal pin of the HF860 and HF819 if it is possible to replace the signal pin without damaging it.

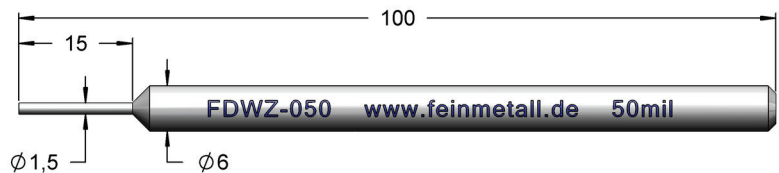

FUWZ-001

With the release tool FUWZ-001 the pin can be released from the flange. The Mini SMP cable connection can also be easily removed without pulling on the cable.

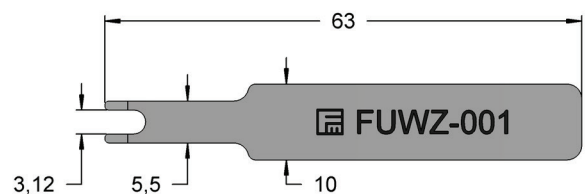

FZWZ-004 / FZWZ-005 / FZWZ-006

With the removal tool, the signal pin of the HF860 or HF819 can be disconnected and replaced.

FZWZ-004 - \varnothing 0,50 - 0,95mm
FZWZ-005 - \varnothing 0,95 - 1,55mm
FZWZ-006 - \varnothing 1,55 - 1,85mm





F086

Internal Contact for RF Probes HF819 and HF860

Centers (mm/mil)	1,27 / 50
Current	3,0 A
R_{typ}	10 mOhm
Temperature	-20°C...+80°C

Spring Force (cN ±20%)

Version	Preload	Nominal
Standard	75	130
SP	75	130

Travel (mm)

Version	Nominal	Maximum
Standard	2,0	3,7
SP	2,0	3,7
Pointing Accuracy		±0,05 mm

Materials and Plating

Plunger	see Tip Style
Barrel	Bronze, gold plated
Spring	Music Wire, gold plated
Receptacle	Nickel silver, gold plated

Accessories

Insertion tool receptacle	FEWZ-050EV
Insertion tool receptacle	FEWZ-050E0
Insertion tool probe	FDWZ-050

Drill Size (mm)

Receptacle press ring as stop	0,99 - 1,00
Receptacle press ring inserted	1,05 - 1,07

Projection Height (mm)

H086CR/8.0 with F086	5,0 - 13,0
H086CR/8.0 with F086...SP	8,1 - 16,1

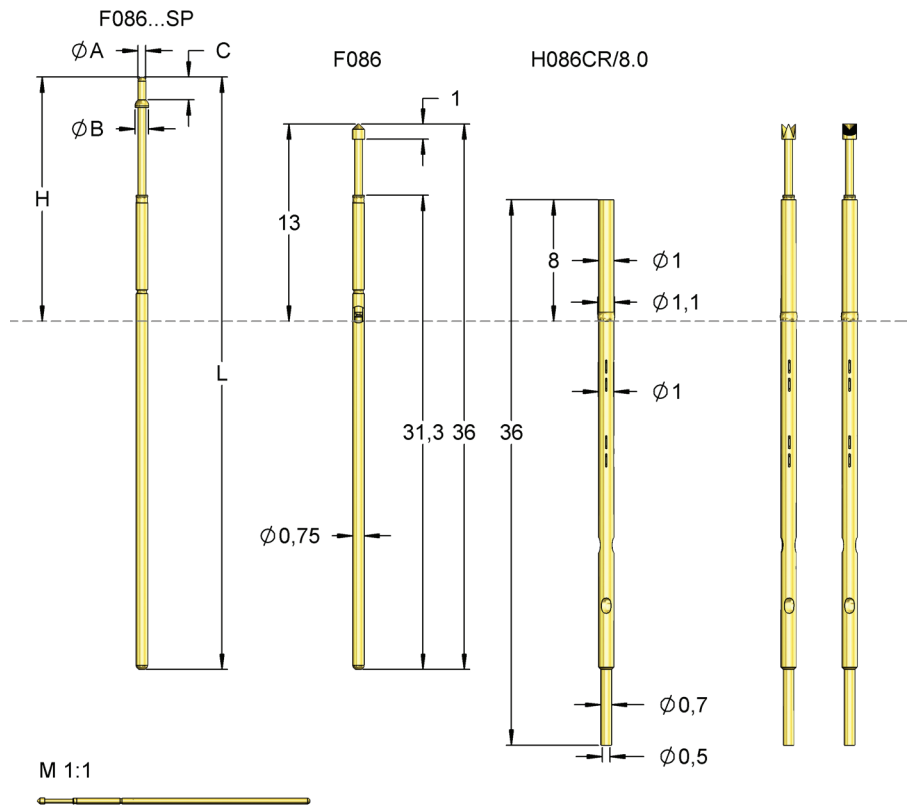

The F086 is mounted in the RF probes HF860 and HF819 as internal contact for signal transmission.

* deviating from standard, depending on diameter.

Tip Style	Number	Material	Plating	Ø in mm	Version
	02	B	G	0,80	-
	02	B	3,00	G	S1
	02	B	G	1,80	-
	05	B	G	0,90	-
	05	B	G	1,50	-
	11	B	G	0,51	-
	14	B	L	0,90	-
	18	B	G	0,51	-
	55	B	G	0,90	-

Series	Tip-Ø	Spring Force (cN)
F086	14	S 090 L 130
	Tip Style	Material Plating Version
Material:	B = BeCu, S = Steel	
Tip-Ø:	090 = 0,90 mm (e.g.)	
Plating:	G = Gold plated, L = Longtime gold plated	
Version:	SP = Step Probe (see table)	
Receptacle:	Order Code according drawing	

Order Code	Tip Style	Ø A	Ø B	C	H	L	Version
F08612B0002G130SP *	12	0,51	0,90	1,50	8,10	39,10	SP
F08612B0004G130SP *	12	0,60	0,90	1,50	8,10	39,10	SP
F08612B0003G130SP *	12	max. 0,60	0,90	1,50	8,10	39,10	SP





CONNECTION CABLES

for Types HF860/HF66

Connection Cables for HF860

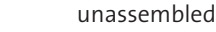
Connection element with pre-assembled coaxial cable RG 316.
Impedance: 50 Ohm
Cutoff frequency: recommended up to **3 GHz**

H86oAE1  Coax cable 3GHz 700 mm  **unassembled**
MCX-M straight

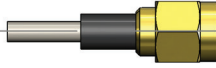
H86oAE3  Coax cable 3GHz 700 mm  **SMA-M straight**
MCX-M straight

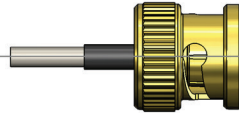
H86oAE4  Coax cable 3GHz 700 mm  **BNC--M straight**
MCX-M straight

Connector with pre-assembled coaxial cable Multiflex 86.
Impedance: 50 Ohm
Cutoff frequency: recommended up to **10 GHz**

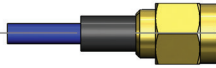

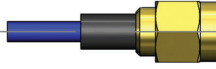
H86oAE2  Coax cable 10GHz 700 mm  **SMA-M straight**
MCX-M straight

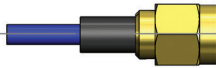

H86oAE5  Coax cable 10GHz 1500 mm  **SMA-M straight**
MCX-M straight



H86oAE6  Coax cable 10GHz 800 mm  **SMA-M grade**
MCX-M angled

Connection Cables for HF66

Connector with pre-assembled highly flexible coaxial cable.
Impedance: 50 Ohm
Cutoff frequency: recommended up to **6 GHz**

H66AE1  Coax cable 6GHz 700 mm  **mSMP-F straight**
SMA-M angled

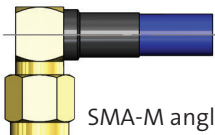
H66AE2  Coax cable 6GHz 700 mm  **mSMP-F straight**
SMA-M straight

H66AE3  Coax cable 6GHz 300 mm  **SMA-M straight**
SMA-M angled